

Operation and maintenance manual

OUTBOARD MOTORS "MO" SERIES



Mitek s.r.l

Addr: Via Paolo Frisi, 70 48124 Ravenna – Italy

VAT - IT02621720396

Phone: +39 0544 264459

Site: www.mitekitaly.com

E-mail: info@mitekitaly.com

Dear customer,

we would like to thank you for your trust in Mitek electric outboard motors.

Each motor has been designed and manufactured for maximum comfort, ease of use and safety, and has been extensively tested before delivery.

We strive to improve our products on a daily basis. If you have any comments on the design and use of our products, we would be pleased to hear from you. Our customer service is always available to answer any questions you may have. Contact details can be found at the back of this manual.

Please read this manual carefully so that you can get the most out of your Mitek outboard motor and enjoy it for a long time.

Enjoy the sea,

Team Mitek, 100% electric motors

Table of contents

1. Use and safety	3
1.1. Important information for safe motor operation	3
1.2. General Warnings	3
1.3. Technical data	4
1.4. Equipment and controls.....	4
1.4.1. The package comes with.....	4
1.4.2. Main components	5
1.5. Electrical connections	5
2. Operating manual	6
2.1. Outboard Installation.....	6
2.2. Batteries.....	6
2.3. Emergency situations	7
2.4. Setting outboard motor mounting height	7
2.5. Pre-operation checks	7
2.6. Starting the motor.....	8
2.7. Tiller handle	8
2.8. Adjusting the speed	9
2.9. Stopping the motor	9
2.10. Gear shift lever.....	9
2.11. Trimming the motor.....	10
2.12. Locking the tiller.....	11
2.13. Tilting up and down	12
2.14. Operating in shallow water.....	14

2.15.	Operating in salt water	14
3.	Maintenance	14
3.1.	Greasing	14
3.2.	Checking wiring and connectors	14
3.3.	Checking for leakage	15
3.4.	Checking the propeller	15
3.4.1.	Removing the propeller	15
3.4.2.	Installing the propeller	16
3.5.	Changing lower unit oil	17
3.6.	Checking and replacing anodes.....	17
3.7.	Checking top cowling	17
3.8.	Maintenance table	18
3.9.	Trailing	18
3.10.	Storing	18
4.	Actions in emergency	19
4.1.	Impact damage	19
4.2.	Not working motor.....	19
4.3.	Submerged motor	19
5.	Remote control connection scheme	20
6.	Warranty	21
7.	Dimensions	23
8.	Voltmeter settings	24

1. Use and safety

Mitek motors are designed for safe and reliable operation.

Please read this manual carefully before operating your motor.

Failure to comply with the following instructions may cause personal injury or material damage.

Mitek srl declines responsibility due to negligence and non-observance of the rules and instructions contained in this manual. We also decline responsibility for damage caused by improper use of the product.

1.1. Important information for safe motor operation

- Before starting a trip, check the status and operation of the motor (including the safety switch which will act as an emergency stop if necessary).
- Familiarise yourself with all the motor control elements.
- The motor should be only operated by adults who have been instructed to do so.
- Comply with the boat manufacturer's instructions regarding the permitted motorisation of your boat. Do not exceed the stated loading and power limits.
- In the event of a person going overboard, stop the motor immediately.
- Do not start the motor if there are swimmers nearby.
- Solar panels or generators can be connected only in parallel with the battery bank

Mitek can refuse warranty claims if the purchased item was in any way modified or equipped with parts or accessory items which are not expressly authorized by Mitek.

Warning: In addition to this information, please pay attention to everything in this manual.

1.2. General Warnings

In addition to the following warnings, please take into account all the information in this manual to prevent damage to your outboard:

- Protect the connectors and the main switches from moisture.
- The motor unit must be lifted or taken out of the water if the boat is driven by other means (e.g. sailing, using other motors) to prevent damage to the electronics.
- Operate the propeller only when it is underwater to avoid damage to the cooling system.
- After use in salt water, rinse the outboard with fresh water and be careful not to get the electronic components wet.
- Before leaving the boat, remove the safety key and disconnect the power connector to prevent accidental starting of the motor and battery discharge when not in use.
- Disconnect the power connector with safety insulated gloves and do not operate the motor if exposed to flood waters.
- Check the sacrificial anode periodically, every 6 months at the latest, and replace it if necessary.
- Always use chargers with galvanic isolation when charging batteries. Your dealer will be able to advise you accordingly.

1.3. Technical data

MODEL	SHAFT	VOLTAGE	STATIC THRUST	WEIGHT
2,6 HP	S (short)	24 V	30 KG	16,5 KG
	L (long)	24 V	33 KG	20 KG
4,5 HP	S (short)	48 V	51 KG	17,5 KG
	L (long)	48 V	54 KG	20 KG
6 HP	S (short)	48 V	65 KG	23,5 KG
	L (long)	48 V	65 KG	24,5 KG
9,9 HP	S (short)	48 V	80 KG	27 KG
	L (long)	48 V	80 KG	28 KG
15 HP	L (long)	48 V	126 KG	49 KG
20 HP	L (long)	48 V	156 KG	56 KG

NOTE: The sizes of the motors can be found on the last pages of the manual.

1.4. Equipment and controls

1.4.1. The package comes with

- A Mitek electric outboard motor
- Battery connector
- Operating manual

1.4.2. Main components

1. Tiller handle
2. Safety switch
3. Display (optional)
4. Tilt leverer
5. Transom brackets
6. Shaft
7. Anti-cavitation plate
8. Propeller
9. Drive/lower unit



1.5. Electrical connections

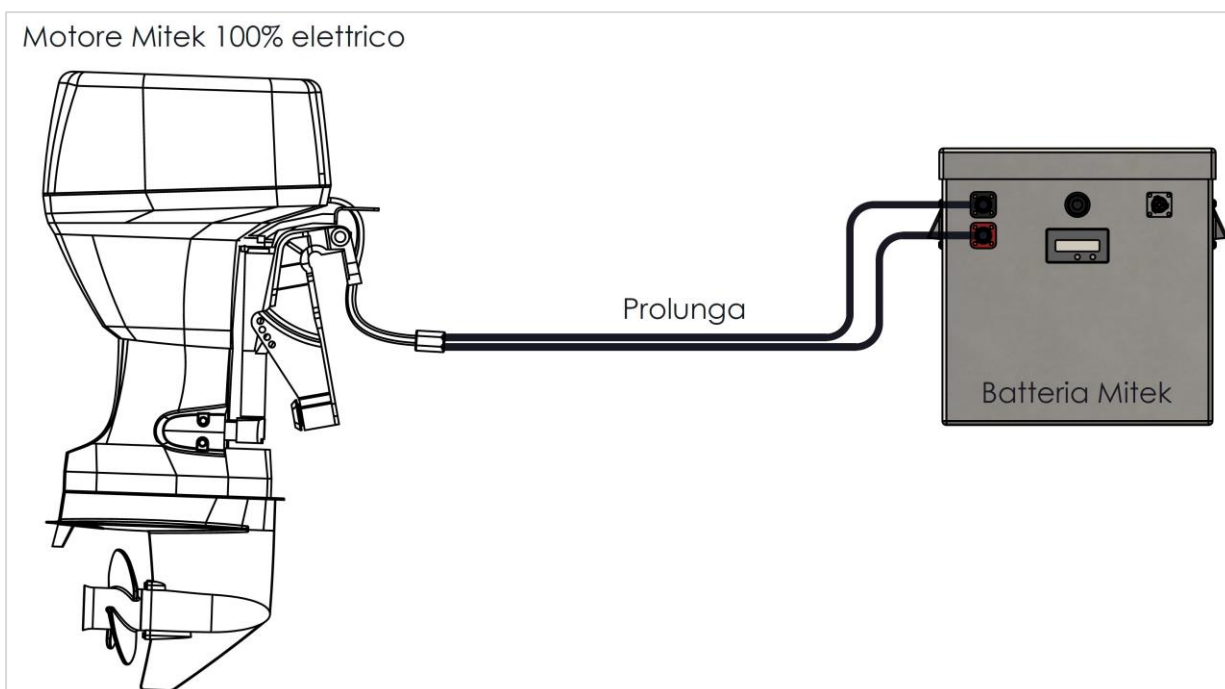

2. Operating manual

2.1. Outboard Installation

Warning: installation should be done by experienced personnel. Please make sure that the installation is carried out on steady footing and that the battery connector is not connected to the motor.



Place the outboard on the transom or outboard mount on the centreline of the boat and tighten the two clamps securely.

Warning: to avoid damage or loss of the motor, check the tightness of the two clamps frequently.



Attach a stop or retaining chain to the eyelet of the outboard if the boat has one.



Check that the motor axis is perpendicular to the water and if necessary move the pin to achieve the correct inclination (trim).

Please note that this function is not available for models MO 2.6HP S and MO 4.5HP S.

To lock the steering function of the engine (e.g. on boats equipped with a rudder) tighten the side screw.



Warning: once the engine has been installed and the boat has reached its maximum load capacity, make sure that there is no danger of water entering the boat from the transom when water rises due to waves; this could cause loss of stability and be very dangerous.

2.2. Batteries

The best choice for your electric outboard motor is to install batteries sold or recommended by Mitek. However, the full range of Mitek MO outboards can be powered with different types of batteries like lead acid, AGM, Gel, and lithium batteries, as long as they achieve the desired capacity according to the needs and autonomy required. It is advisable to contact the service centre for all necessary information.

2.3. Emergency situations

There are two ways to stop the motor rapidly in an emergency:

- Move the throttle lever to 0: the electronics are set to stop the propeller within 1 second
- Remove the safety key.

2.4. Setting outboard motor mounting height

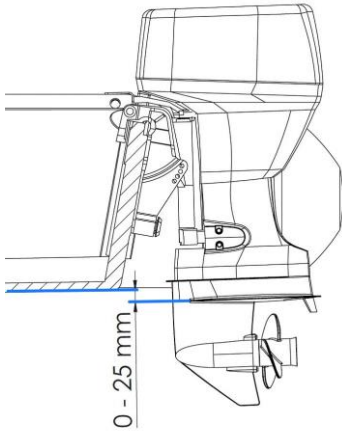

For correct installation, check the installation height in relation to the boat's keel.

If the outboard is mounted **too high** on the transom, cavitation tends to occur and this may result in loss of efficiency, increased noise and damage to the propeller; if the mounting height is **too low**, the water resistance will increase and thereby reduce engine efficiency. There is also a risk that the outboard goes underwater.

The **correct height** of the anti-cavitation plate is 25mm below the bottom of the boat.

The ideal height is influenced by the type of use and the geometry of the hull. Please consult your dealer or boat manufacturer for more information.

The optimum mounting height of the outboard motor is affected by the

shape of the hull and the desired use.

Please consult your dealer or boat manufacturer for more information.

2.5. Pre-operation checks

- Check the integrity of the cables and electrical connections.
- Check that the batteries are charged and securely fastened in the correct position.
- Check that there is no water on the electrical connections and batteries.
- Check the gearbox and steering, they should be smooth.
- Check that there are no loose or damaged fasteners.
- Check the integrity of the propeller.

Warning: if any item in the pre-operation checks is not working properly, please contact our customer service and have it inspected and repaired in order to avoid incidents.

2.6. Starting the motor

Warning: do not operate the motor out of the water, it could get damaged. Handle all electrical equipment with dry hands .

- Attach the engine stop switch lanyard cord to a secure place (e.g. your wrist). Do not attach to clothing that could tear loose.
- Set throttle to 0.
- Connect the battery power connector.
- Accelerate gently and check that there is a steady flow of water from the exhaust.

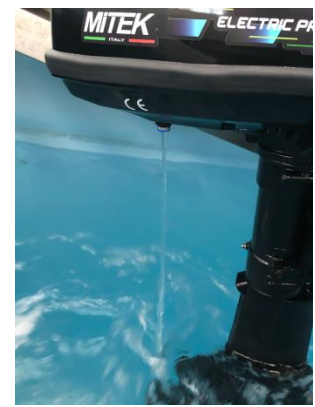

Warning: A continuous flow of water from the cooling water pilot hole shows that the water pump is pumping water through the cooling passages. If water is not flowing out of the hole at all times while the engine is running, over heating and serious damage could occur. Stop the engine and check whether the cooling water inlet on the lower unit or the cooling water pilot hole is blocked. Consult your dealer if the problem cannot be located and corrected. NB: On MO 2.6HP and 4.5HP models, there will be no water flow when operating in reverse.

2.7. Tiller handle



To change direction while operating your boat, move the tiller handle to the left or right.

2.8. Adjusting the speed



To increase or decrease speed, turn the throttle grip.

2.9. Stopping the motor

To stop the motor, turn the throttle grip to zero (turn it clockwise completely).

2.10. Gear shift lever

The gear shift changes from motor to motor.

- MO 2.6hp and MO 4.5hp: to reverse, lock the engine tilt with the lever and press the "R" button.



Warning: to avoid damages in case of collision with the seabed, turn the throttle grip to zero and unlock the motor tilt before moving the gear shift to forward.

- MO 6hp: to reverse, move the gear shift lever:



F = Forward

N = Neutral

R = Reverse

- **MO 9.9hp:** to select the desired direction of travel, move the selector lever towards the direction in which you want to travel (image), as indicated by the FORWARD or REVERSE arrows.



Warning: keep the gear shift lever in DRIVE for forward or reverse and set it to TILT to raise the engine (image).



- **MO 15hp and MO 20hp:** to select the desired direction of travel, move the selector lever towards the direction in which you want to travel (image), as indicated by the FORWARD or REVERSE arrows.



2.11. Trimming the motor

Warning: this procedure cannot be carried out on the 2.6HP S and 4.5HP S models.

- To adjust the trim, remove the pin from the clamp bracket and reinsert it in the correct position so that the motor axis is perpendicular to the water.

Warning: Once the trim has been adjusted, gradually test the boat's stability. An incorrect adjustment of the trim can cause stability problems.



2.12. Locking the tiller



If the boat already has a rudder (e.g. sailboat), you can lock the motor in place with the side screw.

2.13. Tilting up and down

Warning: Be sure all people are clear of the outboard motor when tilting up and down. Be careful not to pinch any body parts between the drive unit and motor bracket.

When the boat is not in use for long periods, or when it is moored in shallow water, or even when it is driven by other means like a sailboat (e.g. sailboat, other engines), the outboard motor should be tilted up in order to avoid damage by collision and reduce strain on the motor.

When the boat is moored in the water, always tilt the motor up so that the lower case remains completely out of the water when the motor is not in use

- **2.6hp model:** switch off the engine, remove the safety key IMAGE 1, set the tilt lock lever to "F" by pulling it out about 10mm, rotate it, tilt the motor up and set the tilt lock lever to "R" to keep it in place. IMAGE 2 To tilt it down again, lift the motor slightly, set the lever to "F" and lower the motor.

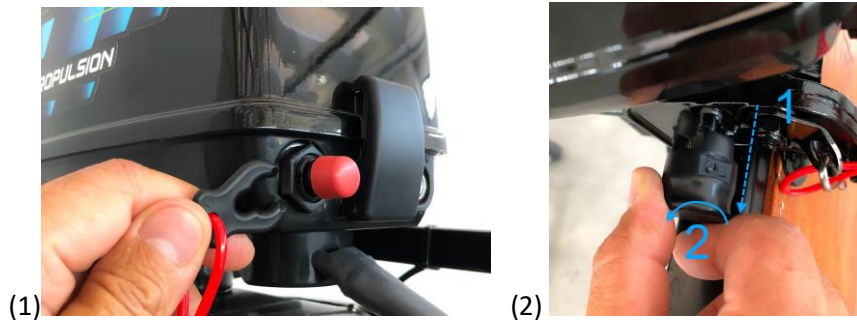

- **6hp and 9.9hp model:** switch off the motor, remove the safety key, set the tilt lock lever to "N", raise the motor, making sure that the tilt lock is engaged properly before lowering the outboard. To lower again, lift the motor slightly, operate the tilt lever and lower the motor.



- **15hp and 20hp models:** switch off the motor, remove the safety key, set the tilt lock lever to “N” on models with tiller control, unlock the tilt by pushing down the "tilt block" lever (Figure 1), lift the engine until the tilt block is engaged by means of the appropriate lever (Figure 2). Make sure that the tilt lock is fully engaged before releasing the motor. To lower again, lift the motor slightly, operate the tilt lever and lower the motor.

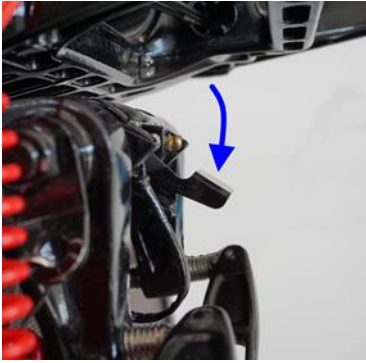

2.14. Operating in shallow water

To navigate in shallow water, unlock the tilt lever and raise the foot of the motor partially, so that it does not hit the bottom.

Warning: do not use the reverse gear when operating in this mode. This could result into damage to things or injuries to people.

Warning: please note that in this mode the motor is free to tilt. You must navigate at the lowest possible speed and accelerate very slowly.

Warning: motor cooling is not guaranteed in this mode. Return the engine to the normal running position as soon as possible.

2.15. Operating in salt water

After operating in salt water, rinse the exterior of the outboard motor and flush the cooling system with fresh water.

3. Maintenance

To ensure safe operation and long life of the motor, we recommend that you perform some minor periodic maintenance.

Warning: before carrying out any maintenance operation, set the throttle to 0 and disconnect the power connector with dry hands.

3.1. Greasing

Use a grease gun to apply marine grease to the following components:



3.2. Checking wiring and connectors

Check the integrity of wires and connectors, and search for any pinched wire or damaged cable sheath and connector.

Use an electrical contact cleaner spray to preserve the efficiency of the connectors.

Warning: if damage is found, disconnect the power connector using insulated gloves and contact the nearest customer service.

3.3. Checking for leakage

Check that there are no leaks around the motor and from the cooling pipes.

Warning: in the event of a leak, switch off the motor, disconnect the power connector and contact the nearest customer service.

3.4. Checking the propeller

Warning: before carrying out this check, switch off the motor and disconnect the power connector.

Check the propeller blades for wear.

Check the propeller shaft for damage.

Check the splines/shear pin (in models MO 2.6 and 4.5) for wear or damage. If necessary replace it.

Check that there are no objects entangled around the propeller (e.g. fish lines).

Check the propeller shaft oil seal for damage. If necessary contact the nearest customer centre.

3.4.1. Removing the propeller

MO 2.6/4.5 HP:

Straighten the cotter pin and pull it out using a pair of pliers.

Remove the propeller.

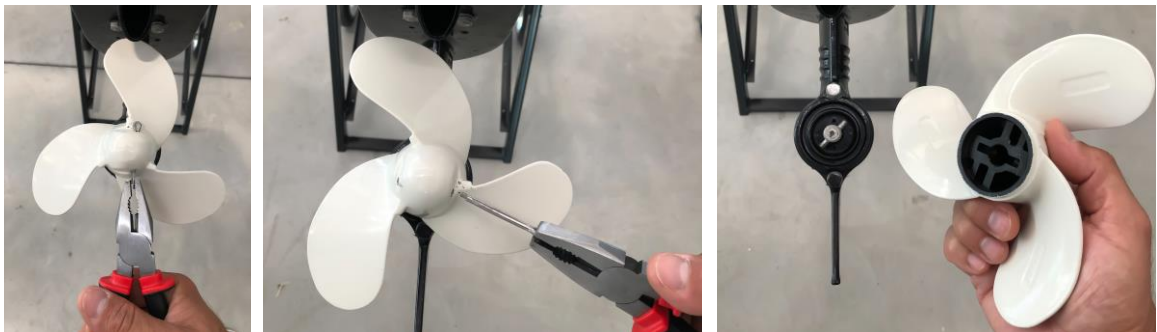

MO 6/9.9 HP:

Straighten the cotter pin and pull it out using a pair of pliers.
Unscrew the retaining bolt and remove the washer.
Remove propeller and reinforcing washer.



3.4.2. Installing the propeller

MO 2.6/4.5 HP:

- Apply marine grease to the propeller shaft.
- Install the shear pin.
- Align the propeller with the propeller shaft hole.
- Insert a new cotter pin in the hole and bend the cotter ends securely.

MO 6/9.9 HP:

- Install the thrust washer.
- Apply marine grease.
- Install the propeller on the shaft.
- Insert the washer and propeller nut, insert the cotter pin and bend the longest ends so that it does not come out.

3.5. Changing lower unit oil

Warning: The lower unit oil should be changed in a dry place. Be sure that the outboard motor is securely fastened to a transom in vertical position. You could be severely injured if the outboard motor falls on you.

Warning: Waste oil is a hazardous waste. It must be collected and disposed of accordingly.

Place a container underneath the motor foot and collect the used oil.
Unscrew and remove the upper plug.
Unscrew and remove the lower plug and allow the oil to drain into the container.

Warning: Inspect the used oil after it has been drained. If the oil is milky, water may have seeped into the gear case, which can cause gear damage. Have your outboard motor checked and repaired.
Screw the lower plug back in and replace the seal with a new one.
Slowly fill the gear oil drain screw hole with oil from the upper plug until it flows out.
Screw the upper plug back in and replace the seal with a new one.

Warning: change the gear oil after the first 10 hours of operation, and every 100 hours or at 6 months intervals thereafter.

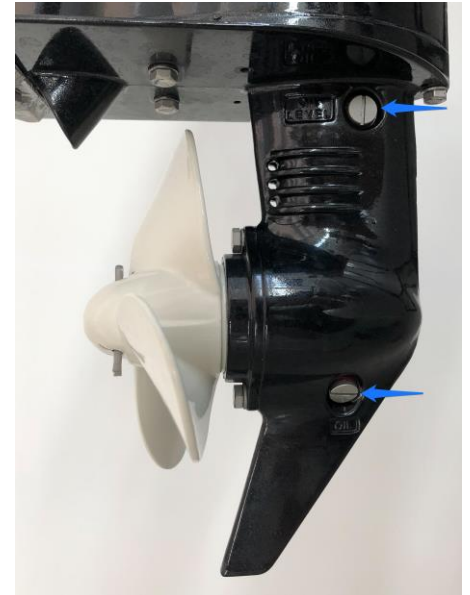

3.6. Checking and replacing anodes



Inspect the external anodes periodically and remove scales from the surfaces of the anodes.

Warning: do not paint the anodes, as this would render them ineffective and can cause rapid corrosion damage.

3.7. Checking top cowling



Check the fitting of the top cowling by pushing it sideways in both directions. If it is loose, have it repaired by the nearest service centre.

3.8. Maintenance table

When used under normal conditions, maintained and repaired properly as illustrated in this manual, we are sure that you will enjoy using Mitek motors for many years. Frequency and maintenance operations may be adjusted according to the operating conditions. The following table gives general guidelines.

A = indicates the check-ups that you can carry out yourself

D = indicates work to be carried out by a service centre

ITEM	ACTIONS	INITIAL		EVERY	
		10 hours (1 month)	50 hours (3 months)	100 hours (6 months)	200 hours (1 year)
Greasing points	Greasing			A	
Wiring and connectors	Check		A	A	
Cooling water passages	Cleaning		A	A	
Propeller and cotter pin	Check / Replacement		A	A	
Lower unit oil	Replacement	A		A	
Anodes	Check / Replacement		A/D	A/D	
Cowling clamps	Check				A
Top Cowling	Check		A	A	

Warning: When operating in turbid water, the engine should be flushed with fresh water after every use.

3.9. Trailering

When trailering the boat, lift or remove the outboard.

Warning: when you remove the outboard, always place it on a protective towel to avoid damage to the motor and surface.

3.10. Storing

Warning: When the outboard motor will not be used for a long period of time (two months or more), it is advisable to place it in a dry, ventilated place away from direct sunlight after performing the following procedures:

- Secure the outboard motor to a rigid structure and insert the shaft into a container of clean fresh water. Make sure that the anti-cavitation plate is completely covered with water.
- Connect the battery using dry hands or insulated gloves.
- Run the motor for at least 2 minutes to flush the cooling system.
- Disconnect the batteries.
- Wash the exterior of the outboard motor with fresh water, dry it and spray it with a protective product.
- Grease clamps and throttle cable under the tiller (except for MO 2.6S and MO 4.5S).



If you do not have the right equipment and are not familiar with these procedures, we recommend that you visit a service centre.

4. Actions in emergency

In case of emergency, please follow the instructions below

4.1. Impact damage

If the outboard hits an object in the water:

- Stop the motor immediately by moving the throttle lever to 0 or removing the safety key.
- Inspect the motor for any damage.
- In the event of damage, do not continue to run the motor and contact the nearest service centre.

If no damage is found after a collision with an object, we still recommend that you have the motor checked at your nearest service centre

4.2. Not working motor

If for some reason you cannot start the motor, please follow the steps below until the problem is solved:

1. Move the throttle lever to 0 and try to accelerate gently.
2. Move the throttle lever to 0, remove the safety key, wait 10 seconds, reinsert it and try to accelerate gently.
3. Move the throttle lever to 0, disconnect the power connector, wait 10 seconds, reconnect it again and try to accelerate gently.
4. Contact a service centre.

4.3. Submerged motor

If for some reason the motor is submerged:

- a) Remove the safety key.
- b) Immediately disconnect the power connector using insulated gloves and take it to the nearest service centre as soon as possible.

Warning: do not try to operate the motor unless it has been checked by a service centre.

5. Remote control connection scheme

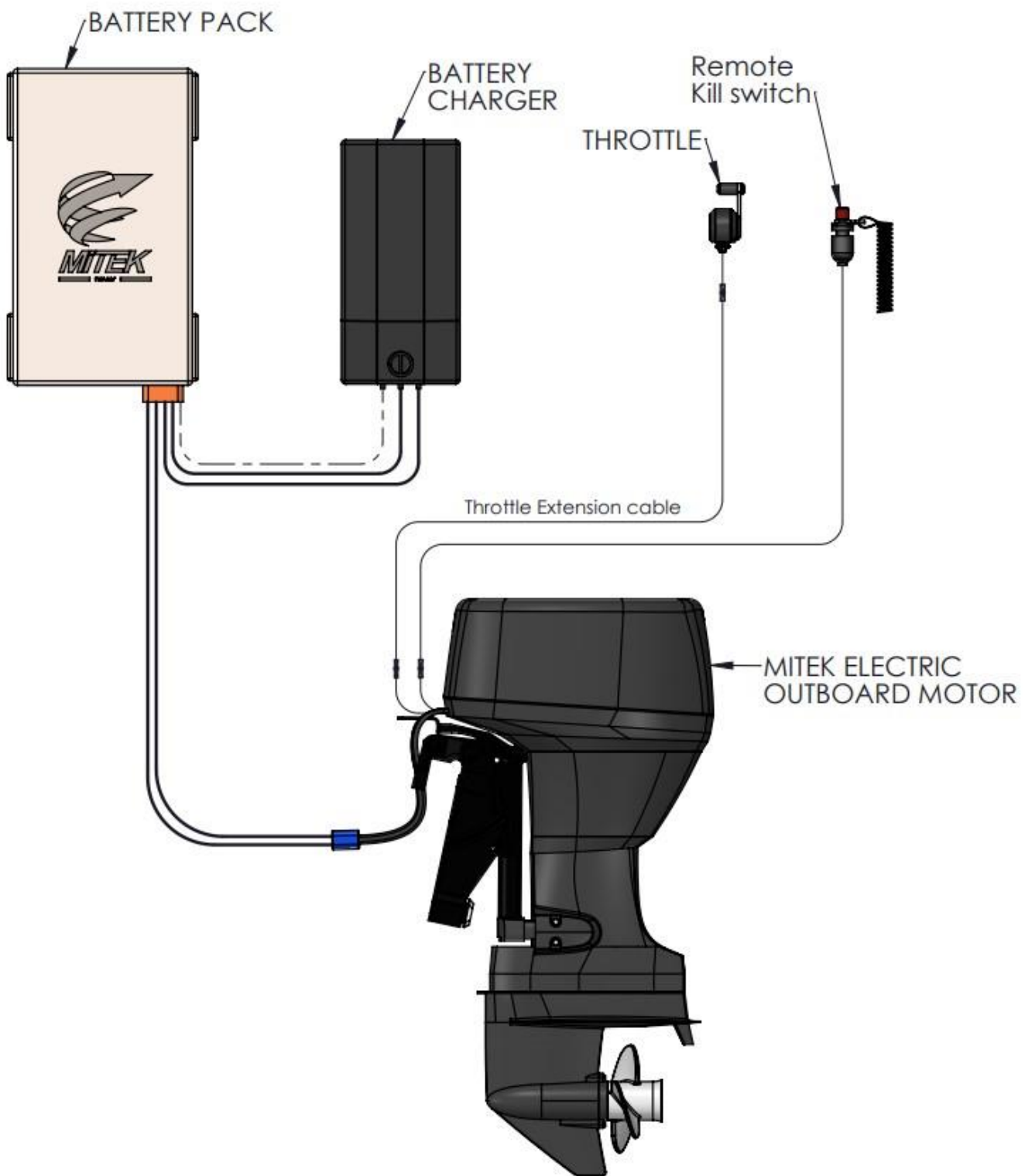

6. Warranty

Warranty: Mitek S.r.l. warrants that new products manufactured by Mitek S.r.l. will remain free from defects in material and workmanship for the period specified below.

PERIOD OF WARRANTY: this limited warranty is valid for a period of two (2) years from the date of first purchase for pleasure boat use, or from the date of first use, whichever comes first. If the product is used for commercial purposes, this warranty provides coverage for one (1) year from the date of original retail sale or one (1) year from the date of first in use, whichever comes first. Commercial use is defined as any professional use of the product, or any use of the product that generates profit, during the warranty period.

Repair: Replacement of components or servicing within the terms of the warranty does not extend the expiry date of the warranty. If the warranty has not expired, it can be transferred to the next purchaser, exclusively for pleasure use, after re-registering the product. An unexpired warranty cannot be transferred from one buyer to the next if the product has been or will be used for commercial purposes. Warranty coverage may be terminated for a used or repurchased product, or for a product purchased at auction, as salvage from a shipyard or from an insurance company.

CONDITIONS FOR THE EFFECTIVENESS OF THE WARRANTY COVERAGE: the warranty coverage is valid only for retail purchasers who make a purchase from an authorized Mitek dealer or directly from Mitek S.r.l. Warranty coverage becomes effective upon registration of the product by the authorised dealer. In order to continue to benefit from the warranty coverage, it is necessary to regularly perform the routine maintenance operations indicated in the operation and maintenance manual. Mitek reserves the right to provide future warranty coverage only upon presentation of proof of proper maintenance procedures.

OBLIGATIONS OF MITEK: Mitek's sole and exclusive obligation under this warranty is limited to repairing a defective component and replacing such component or components with new or remanufactured components, or refunding the purchase price of the Mitek product. Mitek reserves the right to improve or modify its products without assuming any obligation to modify previously manufactured products. Mitek reserves the right to improve or modify its products without assuming any obligation to modify previously manufactured products.

HOW TO OBTAIN WARRANTY COVERAGE: the customer must give Mitek a reasonable opportunity to carry out the repair, as well as access to the product in order to carry out the service operations foreseen by the warranty. Warranty claims must be accompanied by delivery of the product for inspection to a dealer authorised by Mitek or to the premises of Mitek S.r.l. to carry out work on the product. If the purchaser is unable to deliver the product to a dealer, he must inform Mitek in writing, who will inspect it and carry out the repairs envisaged by the warranty. All transport and/or transfer costs shall be borne by the buyer. If the service provided is not covered by this warranty, the purchaser shall bear all labour and material costs and any other costs associated with the service. In order to obtain warranty service, proof of registration of the purchased product must be presented to the dealer when requesting service.

EXCLUSION OF WARRANTY: this limited warranty does not cover routine service work, as well as tune-ups, adjustments, damage caused by normal wear and tear, abuse, misuse, use of the product not in accordance with the operation/service cycle section of the operation and maintenance manual, negligence, accidents, immersion, improper installation (specifications and techniques for proper installation are described in the product installation instructions), improper servicing, use of accessories or components not manufactured or sold by Mitek, use of oils or grease unsuitable for use with the product in question (refer to the operation and maintenance manual), alteration or removal of components, damage to the product caused by insufficient cooling water as a result of obstruction of the cooling system by foreign bodies, operation of the outboard with the water intake not fully immersed. Expenses

associated with hauling, launching, towing, storing, inconvenience, loss of time or profit, or any other incidental or consequential damages are not covered by this warranty. Also not covered are expenses associated with removing and/or replacing parts or material from the boat in order to access the product in question.



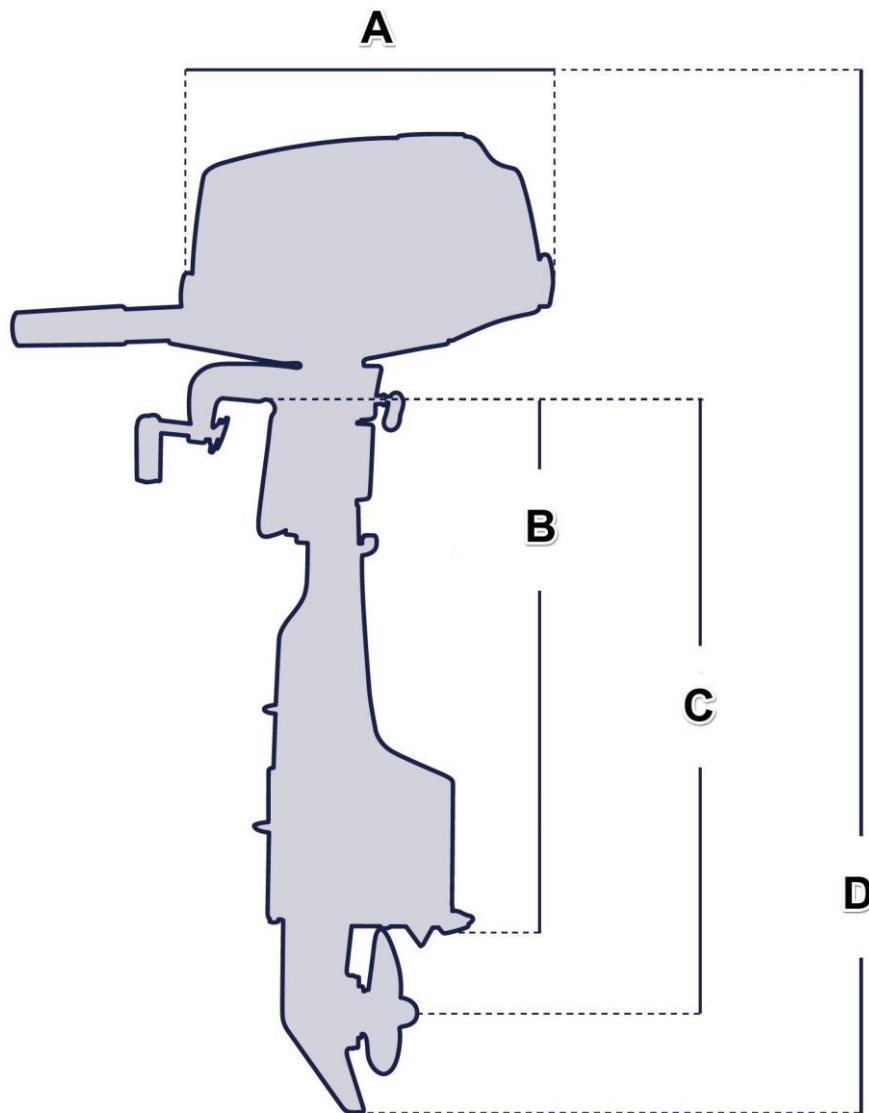



7. Dimensions



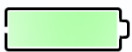

	2.6 HP		4.5 HP		6 HP		9.9 HP		15 HP	20 HP
	S	L	S	L	S	L	S	L	L	L
A	390 mm	430 mm	390 mm	430 mm	480 mm	480 mm	480 mm	480 mm	520 mm	520 mm
B	410 mm	565 mm	410 mm	565 mm	445 mm	565 mm	445 mm	565 mm	580 mm	580 mm
C	530 mm	670 mm	530 mm	670 mm	550 mm	670 mm	550 mm	670 mm	720 mm	720 mm
D	900 mm	1080 mm	900 mm	1080 mm	980 mm	1120 mm	980 mm	1120 mm	1200 mm	1200 mm

8. Voltmeter settings

Display setting options:

	Backlight off
	S1 Display alternately shows V and % of charge, every 2s.
	S2 Display switches off after 10 seconds.
	S3 Backlight on, .
	S4: Not used.
	S5: Not used.

How to set the voltmeter for your battery:





1. Connect the battery to the motor.
2. Press and hold the "settings"  button and, at the same time, switch on the instrument by connecting the safety switch to the rudder bar.
3. Briefly press "settings"  to select the battery type: P, L, F.

Battery Type:

P: lead **L:** lithium-ions **F:** LiFePo4

Standard voltage per cell:

P: 12V **L:** 3.7V **F:** 3.2V

4. Briefly press "change"  until the correct number of cells or number of batteries is selected.
Example: If I have 4 lead acid batteries with a total of 48V, I select P 04.
5. Press and hold the "change" button  to access all display modes S1-S5.
6. to choose the preferred display, briefly press "settings"  to select the mode (e.g. S1) and then briefly press "change"  to activate or deactivate the mode. Carry out the same procedure for all modes (S1, S2, S3, S4, S5).
Example: If I want the display to automatically show V and % of charge every two seconds while remaining constantly backlit, I must activate mode S1 and S3 and deactivate the remaining modes.
7. Switch off the instrument to save the parameters.

Attention: by deactivating all modes except S3, it will be possible to have the display always backlit and by briefly pressing "change"  it will be possible to manually choose whether to display the battery % or the Voltage or to switch off the display.



MITEK

ITALY

Mitek s.r.l

Addr: Via Paolo Frisi, 70 48124 Ravenna – Italy

VAT - IT02621720396

Phone: +39 0544 264459

Site: www.mitekitaly.com

E-mail: info@mitekitaly.com

All information in this manual is based on the latest product information available at the time of printing. The data and illustrations contained in this manual may vary and do not form the basis of any claim against Mitek Srl. No part of this manual may be reproduced without written permission.